



## WARN Industrial Winch

**Model**

**Part Number**

**Motor Type**

**Series 9-A-1D  
Electric Winch  
Manual Clutch**

**30283**

DC Electric  
12 Volt  
Series Wound

The Series 9 DC features a weatherproof industrial contactor and heavy duty remote control. The disc brake is designed for extended power-out use and the motor is protected by a thermal over-load switch. Its lower gear ratio of 199:1 provides a fast line speed. Designed to meet SAE J706 and CE standards.

\*Remote Control Assembly, 10m included



### Accessories

Description:	Part Number
Wire Rope Tension Plate 10"	31149
Fairlead Black 10"	24336
Fairlead Chrome 10"	30859
Remote Clutch Mechanical	38316
Remote Clutch Air	71370
Wire Rope Assembly 3/8"x125' EIPS	23674

### Engineering Data

Rated Pulling Force:	9000 lbf	4082 kgf
Drum Barrel Diameter:	4.0 in	102 mm
Drum Flange Diameter:	8.24 in	209 mm
Distance Between Flanges:	9.95 in	253 mm
Recommended Maximum Wire Rope Diameter:	1/2 in	12.7 mm
Recommended Minimum Wire Rope Breaking Strength:	15,100 lbf	6849 kgf
Approximate Shipping Weight:	95.0 lb	43.1 kg
Duty Cycle (intermittent per SAE J706 section 6.2):	75 ft	22.9 m
Mounting Bolt Torque:	35 - 40 ft*lb	47 - 54 N*m
Maximum Layers of Wire Rope:	4 (with 3/8" rope)	
Gear Reduction:	199:1	
Brake Type:	Disk	
Contactor / Remote Type:	Industrial contactor with 33' (10m) heavy duty remote	

### Drum Rotation

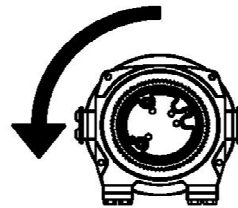

Viewed from Motor End

### Standards Compliance

- SAE J706
- CE Machinery Directive 98/37/EC and 2006/42/EC
- CE Electromagnetic Compatibility 2004/108/EC

### Performance By Layer- 3/8" (9.5 mm) dia. rope

Drum Layer	Line Load *			No Load Line Speed		Drum Capacity	
	lbf	kgf	kN	ft/min	m/min	ft	m
1	9000	4082	40.0	26.0	7.9	25	7.6
2	7518	3410	33.4	31.1	9.5	54	16.5
3	6455	2928	28.7	36.3	11.1	88	26.8
4	5655	2565	25.2	41.4	12.6	126	38.4

\* Never exceed the Rated Pulling Force. Installation of a Rated Capacity Limiter is recommended.

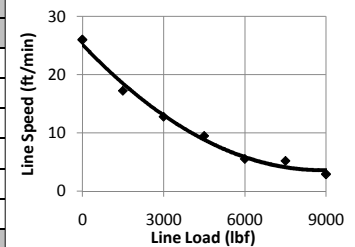

### First Layer Performance

Line Load		Current Draw	Line Speed		Duty Cycle
lbf	kgf	Amps	ft/min	m/min	min/10min
0	0	101.0	26.0	7.9	4.1
1500	680	169.1	17.2	5.2	2.1
3000	1361	233.0	12.8	3.9	1.4
4500	2041	296.9	9.5	2.9	1.1
6000	2722	362.9	7.9	2.4	0.9
7500	3402	424.7	7.2	2.2	0.7
9000	4082	486.0	6.8	2.1	0.6

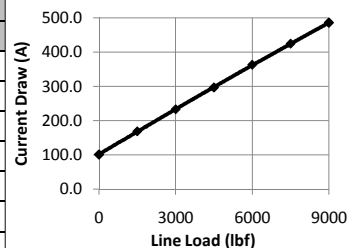

**WARN INDUSTRIES, INC**  
Industrial Products

Customer Service (North America): 1.800.543.9276  
Customer Service (International): 1.503.722.3008  
FAX: 1.503.722.3000 www.warn.com

12900 S.E. Capps Road,  
Clackamas, OR USA 97015



# WARN Industrial Winch

Model	Part Number	Motor Type
Series 9-A-1D Electric Winch Manual Clutch	30283	DC Electric 12 Volt Series Wound

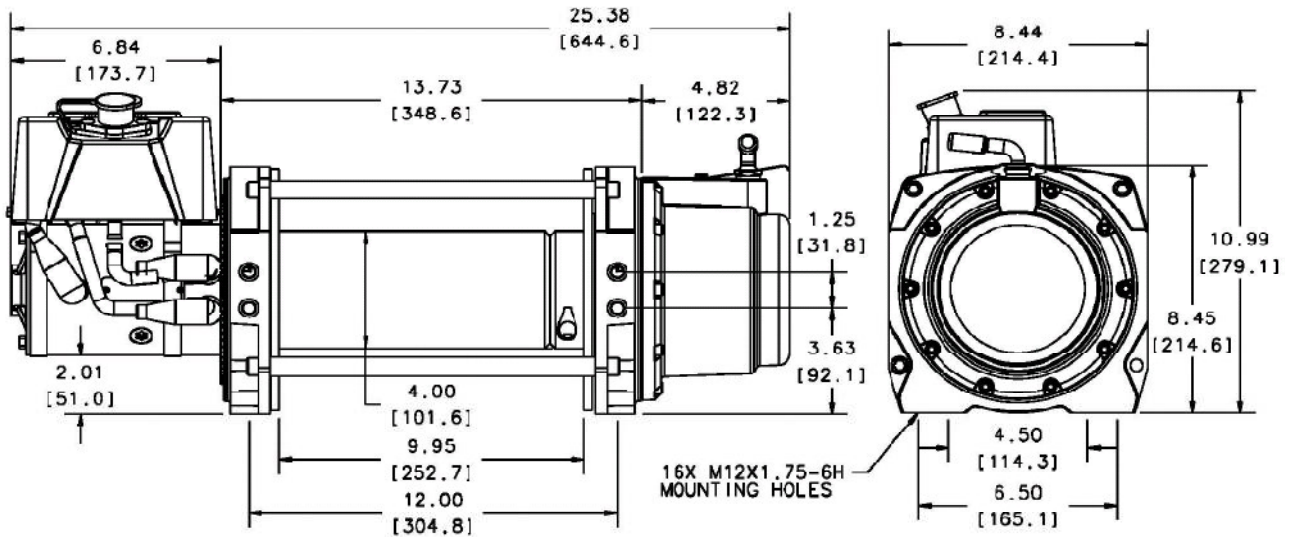

Motor / Contactor may be rotated in 90 degree increments. Clutch housing may be rotated in 72 degree increments.

Units are given in inches [millimeters], unless otherwise specified

Recommended Mounting- Always Observe Correct Drum Rotation			Electrical System Specifications
Pull from bottom of winch	Pull from bottom of winch	Pull from top of winch	650 CCA Battery Minimum
			See Electrical Cable Gauge Size Chart for cable sizing
Feet down	Feet forward	Feet forward	All electrical connections must be clean and tight
Pull from top of winch	Pull from top of winch	Pull from top of winch	<b>Electrical System Wiring Schematic</b>
Feet down without angle brace	Feet down with angle brace	Angle Braces Only	Notes:

**WARN INDUSTRIES, INC**  
Industrial Products

Customer Service (North America): 1.800.543.9276  
Customer Service (International): 1.503.722.3008  
FAX: 1.503.722.3000 www.warn.com

12900 S.E. Capps Road,  
Clackamas, OR USA 97015