



WARN Industrial Winch

Model	Part Number	Motor Type
Series 30XL Hydraulic Winch Manual Clutch	77890	Hydraulic 10.4 ci (170cc)



The Warn Series XL product line combines durable cast iron construction, high efficiency hydraulic motor, and a robust 2X rated load braking system with a permanently lubricated and hardened 2-stage planetary gear train for superior intermittent-duty performance for loads up to 30,000 lbs. Winches are also available with manual or air clutches and 2 drum widths. A roller tension plate is standard along with bi-directional operation and a variety of mounting options to fit a variety of applications.

Warn Series XL winches are not suitable for hoisting applications or movement of persons.

Accessories

Description:	Part Number
Fairlead SRS-XL-LONG	77869
Wire Rope Assembly 5/8"x245' EIPS	77454
Snatch Block XL-60K LB	80858

Engineering Data

Rated Pulling Force:	30000	lbf	13608	kgf
Drum Barrel Diameter:	6.25	in	159	mm
Drum Flange Diameter:	13.50	in	343	mm
Distance Between Flanges:	14	in	356	mm
Recommended Maximum Wire Rope Diameter:	5/8	in	15.9	mm
Recommended Minimum Wire Rope Breaking Strength:	41200	lbf	18688	kgf
Approximate Shipping Weight:	361	lb	164	kg
Duty Cycle (intermittent per SAE J706 section 6.2):	1000	ft	304.8	m
Mounting Bolt Torque:	159	ft*lb	216	N*m
Maximum Layers of Wire Rope:	5			
Gear Reduction:	36:1			
Brake Type:	Spring Applied Disk			
Contact / Remote Type:	N/A			

Drum Rotation

Viewed from Motor End

Standards Compliance

- SAE J706
- CE Machinery Directive 98/37/EC and 2006/42/EC

Performance By Layer- 5/8" (15.9 mm) dia. rope

Drum Layer	Line Load *			Line Speed 15 GPM		Line Speed 20 GPM		Drum Capacity	
	lbf	kgf	kN	ft/min	m/min	ft/min	m/min	ft	m
1	30000	13608	133.4	14.1	4.3	21.9	6.7	36	11.0
2	25385	11514	112.9	16.7	5.1	25.9	7.9	78	23.8
3	22000	9979	97.9	19.2	5.9	29.9	9.1	127	38.7
4	19412	8805	86.3	21.8	6.6	33.9	10.3	183	55.8
5	17368	7878	77.3	24.3	7.4	37.8	11.5	245	74.7

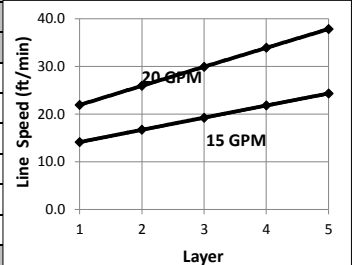

* Never exceed the Rated Pulling Force. Installation of a Rated Capacity Limiter is recommended.

First Layer Performance

Line Load		Pressure Drop at 15 GPM		Pressure Drop at 20 GPM		Duty Cycle
lbf	kgf	psi	BAR	psi	BAR	min/10min
0	0	875	60.3	975	67.2	N/A
7500	3402	1250	86.2	1533	105.7	N/A
15000	6804	1900	131.0	2050	141.3	N/A
22500	10206	2500	172.4	2600	179.3	N/A
30000	13608	3000	206.8	2950	203.4	N/A

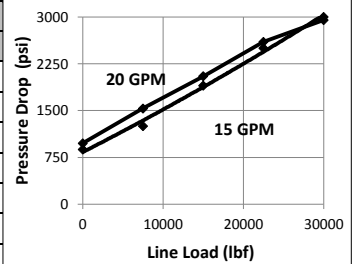



WARN Industrial Winch

Model

Part Number

Motor Type



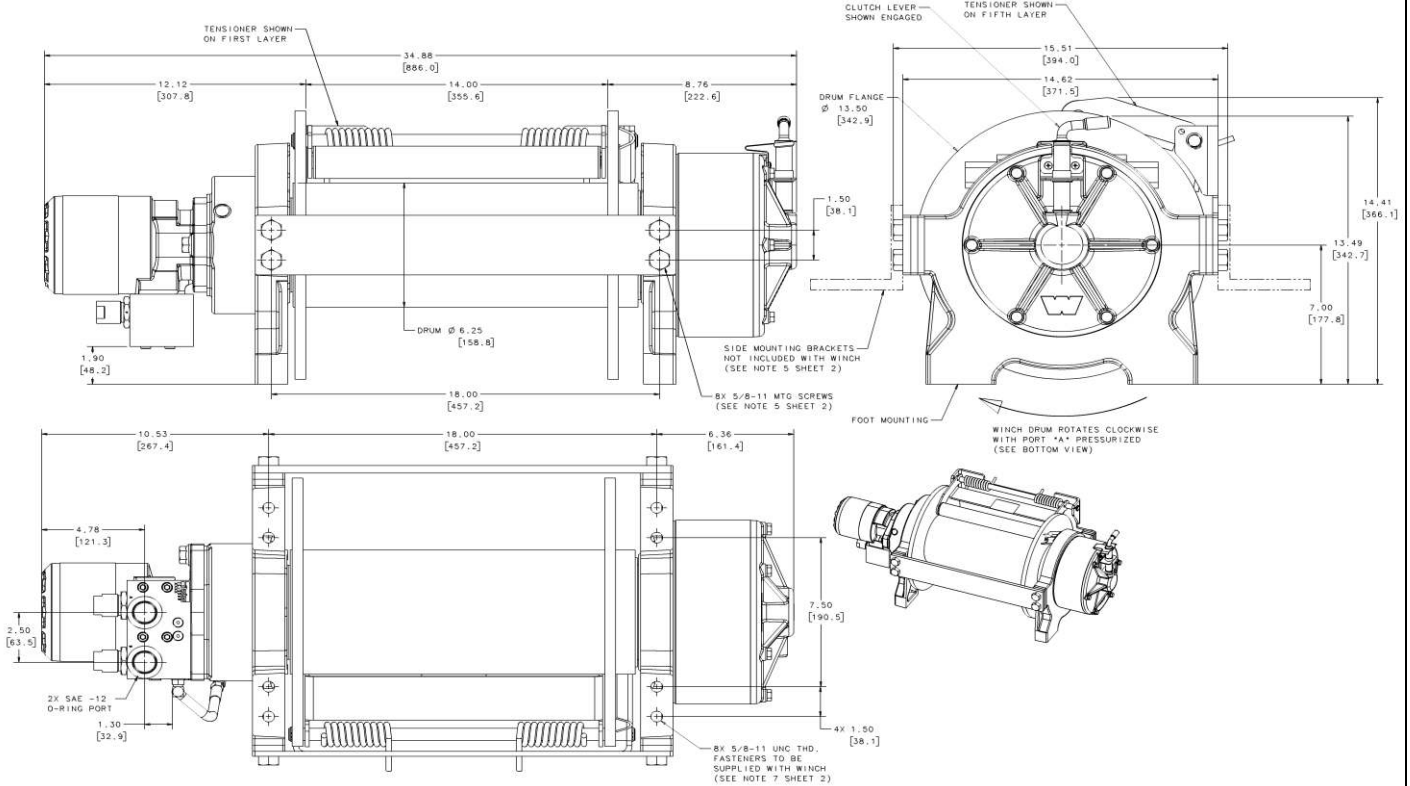

Series 30XL
Hydraulic Winch
Manual Clutch

77890

Hydraulic
10.4 ci (170cc)

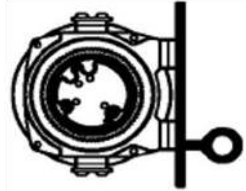
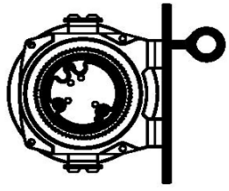
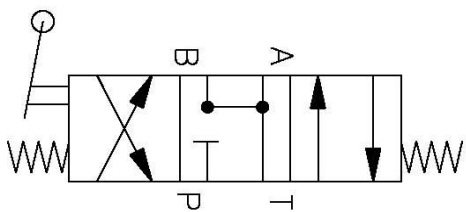

Motor / Contactor may be rotated in 90 degree increments. Clutch housing may be rotated in 60 degree increments.
Units are given in inches [millimeters], unless otherwise specified

Recommended Mounting- Always Observe Correct Drum Rotation			Hydraulic System Specifications		
Pull from bottom of winch  Feet down	Pull from bottom of winch  Feet forward	Pull from top of winch  Feet forward	Maximum System Pressure:	3000 psi	207 BAR
			Maximum Motor Pressure Drop:	3000 psi	207 BAR
			Maximum Rated Input Flow:	20 GPM	76 LPM
			Control Valve Type:	3-position, 4-way, open center, spring return (motor spool)	
Control Valve Schematic					
					
Pull from top of winch  Feet down without angle brace	Pull from top of winch  Feet down with angle brace	Pull from top of winch  Angle Braces Only			
Note: Drum rotates clockwise with Port A pressurized when viewed from gearbox end.					

WARN INDUSTRIES, INC
Industrial Products

Customer Service (North America): 1.800.543.9276
Customer Service (International): 1.503.722.3008
FAX: 1.503.722.3000 www.warn.com

12900 S.E. Capps Road,
Clackamas, OR USA 97015